

CONSTRUCTION BOARDS

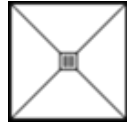

ITALIAN SHOWERS

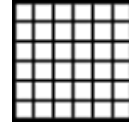

MOSAICS



U-Tile DATASHEET

TILEABLE SHOWERTRAY SLIM Board

SLIM BOARD TILEABLE SHOWERTRAY

Tileable showertray with integrated waterproof mat

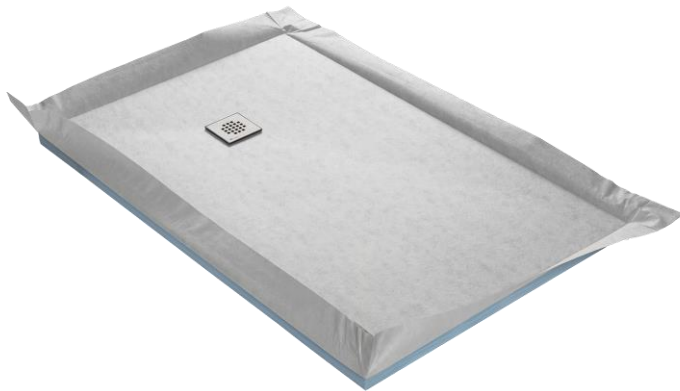

- ENHANCED MECHANICAL RESISTANCE
- COMPATIBLE WITH ALL TILES
- SUITABLE FOR PRM SHOWERS

SLIM Board Lifestyle



The U-Tile SLIM BOARD tileable tray consists of a standard square outlet integrated with an ultra-low-profile 22mm extruded hard foam tray, reinforced with mortar based on polymerized cement with fiberglass mesh. This combination allows the tray to be light, extremely mechanically resistant and can be cut. The tray is designed with 4 slopes with a 1% gradient for quick and easy drainage of water. The trays are all designed with an integrated waterproof mat that protrudes 10 cm on each side of the tray to ensure peripheral sealing along with a quicker and safer installation. The 4 slopes ensure a level surface on all 4 sides of the tray which guarantees a level installation of shower screens and side walls, whilst providing good drainage over the entire tray. The trap utilized is an Ultra-Low-Profile trap that can swivel 360°. 6 sizes are available from square to rectangular for bath replacements.

AVAILABLE GRIDS FOR THE SLIM BOARD RANGE



SQUARE GRID
(STANDARD)

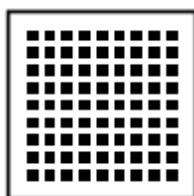

SQUARE GRID 2

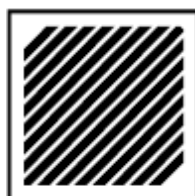

DIAGONAL GRID

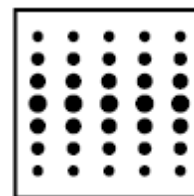

ROUND GRID

SLIM BOARD TILEABLE SHOWERTRAY

References and Dimensions

REF	DESCRIPTION	FORMAT	LENGTH (MM)	WIDTH (MM)	THICKNESS (MM)	POSITION OF TRAP
RC 90 SLIM	SLIM ULTRA-LOW-PROFILE TILEABLE 900 X 900 SHOWERTRAY	SQUARE SHAPE CENTRE TRAP	900	900	67	400/400
RC 100 SLIM	SLIM ULTRA-LOW-PROFILE TILEABLE 1000 X 1000 SHOWERTRAY		1000	1000	67	450/450
RC 120 SLIM	SLIM ULTRA-LOW-PROFILE TILEABLE 1200 X 1200 SHOWERTRAY		1200	1200	67	500/500
RC 12090 SLIM	SLIM ULTRA-LOW-PROFILE TILEABLE 1200 X 900 SHOWERTRAY	RECTANGULAR SHAPE OFFSET TRAP	1200	900	67	600/600
RC 150100 SLIM	SLIM ULTRA-LOW-PROFILE TILEABLE 1500 X 1000 SHOWERTRAY		1500	1000	70	500/320
RC 18590 SLIM	SLIM ULTRA-LOW-PROFILE TILEABLE 1850 X 900 SHOWERTRAY		1850	900	70	450/320

Technical Characteristics

DESCRIPTION	TEST	RESULT
Compressive Force	(ASTM C579)	0.5 N/mm ²
Fire Characteristics	EN 13501-1	CLASS E
Density		36 ± 0.02 kg/m ³
Grip	BS EN 1384	0.3 N/mm ²
Water Absorption in Immersion	DIN 53428	0.02% byVol
Water Absorption (Capillary)	DIN 53428	NIL

Total Displacement Including Tray	67mm – 70mm
Flowrate	Approx 33.6 Litres per minute
Outlet Diameter	40mm
Grid Size	115 x 115mm
Tiling Height Adjustment	7 – 16mm

SLIM BOARD SHOWER TRAYS

SQUARE OR RECTANGULAR 360° ORIENTABLE ULTRA-LOW-PROFILE TRAP

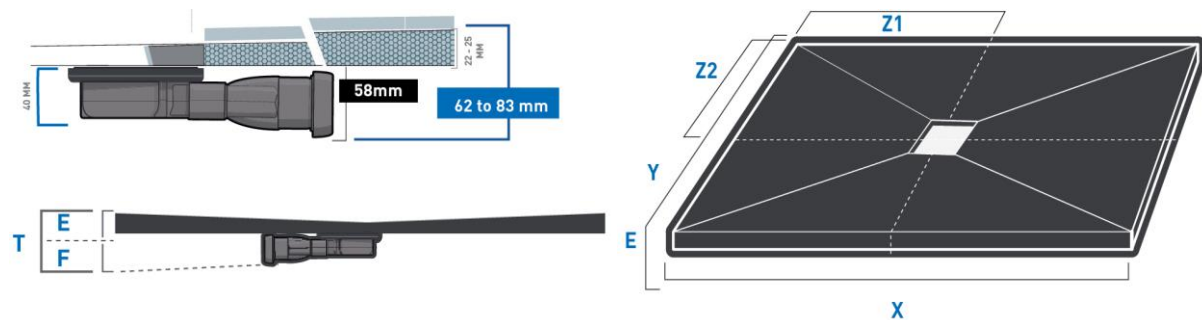

	X	Y	Z2 / Z1	E	F	T
REF	LENGTH (MM)	WIDTH (MM)	POSITION OF TRAP	THICKNESS OF TRAY (MM)	DISPLACEMENT UNDER TRAY (MM)	TOTAL DISPLACEMENT INCLUDING TRAY (MM)
RC 90 SLIM	900	900	400/400	22	40 to 58	62 to 83
RC 100 SLIM	1000	1000	450/450			
RC 120 SLIM	1200	1200	500/500			
RC 12090 SLIM	1200	900	600/600			
RC 150100 SLIM	1500	1000	500/320			
RC 18590 SLIM	1850	900	450/135			

U-Tile SA (Pty) Ltd, 64 Bluewater Drive, Bluewater Bay, Port Elizabeth, 6210

Tel: +27 83 629 4340, +27 41 466 0218

graham.hogg@u-tile.co.za - www.u-tile.co.za